

Installation guide

**ENGINEERED,
HERRINGBONE AND LOC**
3/8", 1/2" and 3/4"
(8,5 mm, 13 mm and 19 mm)



MERCIER

wood flooring

It is important to read the installation instructions, Maintenance guide and the 35/5 Warranty document prior to installation.

Installation that does not respect the instructions may void your warranty.

For questions concerning the installation process, please contact your authorized Mercier retailer or contact Mercier's technical department at **1-866-448-1785**.

Products description

Engineered, Herringbone and LOC floors are specially designed to suit all situations, including basements, floors with radiant heating systems¹ or direct installation on a concrete subfloor. Engineered floors comprise a solid wood surface glued on premier quality hardwood plywood. LOC floors consist of a solid wood surface glued to a central panel of high density fibreboard (HDF). Sanding and finishing of Engineered, Herringbone and LOC products are performed at the factory, under ideal conditions, in accordance with the same quality and precision requirements that have made Mercier's Solid hardwood boards a synonym of excellence.

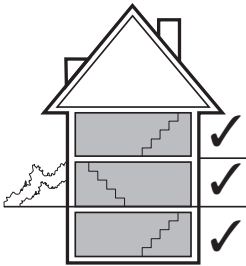

Recommended use

- | | |
|-------------------------|-----|
| • 1 st floor | Yes |
| • Ground floor | Yes |
| • Basement | Yes |

¹ See Technical bulletin #5 for the complete list of non-recommended species to use with a radiant heating system. www.mercierwoodflooring.com

Recommended material and tools

1. Vacuum cleaner or broom
2. Miter-box saw
3. Measuring tape
4. Chalk line
5. Square
6. Handsaw
7. Mercier Touch-up kit
8. Hammer and Tapping block
9. Mercier Maintenance kit
10. Table saw
11. Leveller or sander (if needed)
12. Reversing tongue (if needed)

This is not an exhaustive list of installation tools that could be required. Please note that Mercier Wood Flooring is not responsible for the damages caused by tools or the inappropriate use of materials.

Glued installation

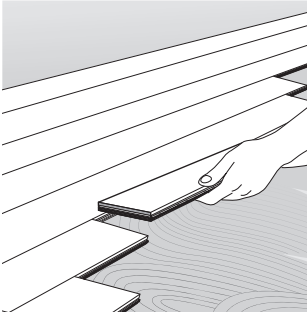

Engineered 3/8" (8,5 mm), 1/2" (13 mm) and 3/4" (19 mm) platforms only

- Use a urethane-based, waterless adhesive
Recommended adhesives:
Finitech AD-532+ / AD-844 MS
Franklin 811
Bostik's Best, EFA+, BST
- Trowel recommended by the manufacturer of the adhesive used
- Blue adhesive tape, 3M brand or equivalent
- Guide slats and concrete nails (to support and to set the first row)
- 100 to 150 lb. (45 to 68 kg) roller
- Cleaner for urethane adhesive
- Mercier ProteXsound DGD acoustic membrane

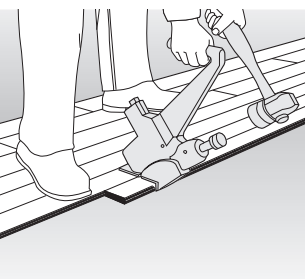

Nailed or stapled installation

Engineered 3/8" (8,5 mm), 1/2" (13 mm) and 3/4" (19 mm) platforms only

- Stapler or nailer for hardwood (pneumatic or manual)
- Drill and 3/32" bit
- Spiral finishing nails and nail punch
- Floor screws

See Technical bulletin #9 for the complete fastener selection table at www.mercierwoodflooring.com

Floating installation

Engineered 1/2" (13 mm) and 3/4" (19 mm) and Mercier LOC platforms²

Recommended adhesive and membrane:

- PVA Type II wood covering glue
- ProteXsound LOC acoustic membrane (or an equivalent membrane with a maximum thickness of 1/8" [3 mm]; ≥ 5 psi, with 25 % compression)

Installer and owner's responsibility

Prior to laying the floor, the installer and the owner must make sure that the installation site and subfloor comply with the conditions specified in this document. The installer and the buyer have the responsibility to inspect the wood boards prior to their installation. Mercier products meet stringent quality standards and comply with the standards in force in the wood flooring industry. These allow a rate of imperfection not exceeding 5% of the quantity of the purchased boards. This rate includes the natural imperfections of the wood, manufacturing defects and selection of the grade.

² Excluding 1/2" x 6 1/2" in Hickory and 8 1/8" PLUS in Hard Maple, Red Oak and White Oak products.

If the installer doubts the grade selection, the manufacturing or finishing quality, and cannot place the board in a less conspicuous place, nor eliminate imperfection, he/she should not install it. Once the board is installed, it shall be considered as having been accepted by the installer and the owner, even if the latter is absent at the time of installation.

According to the site and the type of installation³, the wood flooring order should provide for 3 to 5% additional recovery to compensate for the loss caused by the cuts. Mercier will only replace products with a defect rate exceeding the acceptable 5% (excluding the 3 to 5% cutting loss). **Mercier cannot be held liable for improper installation of its products or poor judgment by the installer. Mercier assumes no labour or installation charges.**

Warranty

Limited lifetime structural warranty 35-year warranty on Mercier Generations GREENGUARD certified finish

The manufacturer “Mercier Wood Flooring” warrants to the original purchaser that the Mercier Generations GREENGUARD certified finish will resist full wear⁴ and surface peeling for a period of:

- 35 years from the date of the purchase, when used under normal residential traffic conditions.
- 5 years from the date of the purchase, when used under light commercial conditions.

Preparation of the installation site

Hardwood floor installation should be the very last step in your project. Before the flooring boards are delivered, inspect the installation site to make sure that:

- The concrete, plaster, paint and the subfloor are completely dry.

³ Installation at angle generates more significant cut losses that could reach 7-9%.

⁴ Wear must be obvious and represent at least 10% of the total floor area. Refer to the Mercier 35/5 Warranty document for more information.

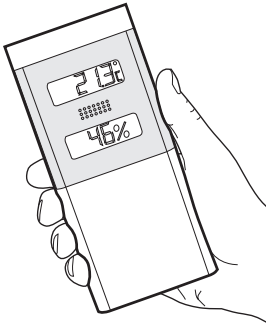

- The building is kept within normal ambient conditions for at least one (1) week prior the floor laying.

LOC products: A temperature of about 20°C (68° F) and a relative humidity between 35 and 55% .

Engineered products: A temperature of about 20°C (68° F) and a relative humidity between 30 and 65% .

The installer must check the humidity of the subfloor (plywood or OSB) at various locations using a moisture meter for wood. The moisture content of the subfloor must never exceed 12% and the gap between the subfloor and the wood boards must not exceed more than 4% of the rate of internal moisture of the boards. If the humidity of the subfloor or the gap is too high, heat, ventilate or dehumidify the site, and delay the delivery and installation of the floor.

If the subfloor is made of concrete slabs, plan a drying period of at least 30 days to test for a reliable humidity level. **Measurements should not exceed 4% using a concrete moisture meter.** If there is moisture, test using calcium chloride. **The moisture rate using the calcium chloride test must not exceed 3 lbs. per 1000 sq. ft. over 24 hours.**

Preparation and correction of the subfloor

- The surface of the subfloor must be free of any defect. If not, fill the cavities with levelling cement and sand irregularities.
- **The subfloor must be level, i.e., it must not present an elevation gain of more than 3/16" (5 mm) over a distance of 10' (3 m).**
- The surface must be clean and free of contaminants such as grease, dust, oil, nails, staples or other materials.
- For a glued installation on concrete slabs, make sure that the concrete is not low density (less than 3000 psi) or crumbly.

- If applicable, make sure that ceramic tiles, acoustic membrane or any other former flooring firmly adheres to the subfloor (for a glued installation).
- For a nailed installation, the subfloor must be securely attached to the joists to avoid panels moving and creaking. Use floor screws as needed.

Once the ideal conditions have been obtained...

Verify that the product is consistent in terms of specie, grade, color, width and quality. Store the boxes in the room of installation at least 24 hours before. Make sure the woodfloor boards are at the same temperature as the laying site, i.e. at about 20°C (68°F). Please notify your dealer immediately if there is a problem. Never store the hardwood boards in an unsuitable location, such as a shed, an unheated garage or a basement.

Recommended method to install boards

- Select boards from at least 3 boxes at a time to ensure uniformity of installation.
- Use a protective surface to place tools and the floor nailer.
- Prior to start the installation, cut the bottom of the moldings around the doors to insert the hardwood boards.
- Plan your project by making a sketch of the installation.
- Determine the starting point of the installation.
- Choose the direction of the hardwood boards. It is strongly recommended to install the wood boards at an angle of 45° or 90° to joists (does not apply to installation on concrete).
- An expansion gap is required to allow wood to react to changes in humidity. Expansion gaps will be hidden by the baseboard or quarter-round which must be nailed to the wall and not to the floor.

Glued installation

Mercier's Engineered 3/8" (8,5 mm), 1/2" (13 mm) and 3/4" (19 mm) floors can be glued directly onto a subfloor that is either made of concrete or wooden, ceramic tile or linoleum on the ground floor, upstairs and even in the basement.

Board installation

- Using chalk line, draw a line parallel to the starting wall at a distance of 1/2" (13 mm) more than the width of the boards (e.g.: 3 3/4" [95 mm] for 3 1/4" [83 mm] boards). The space between the wall and the starting point is the last section of floor that will be installed.
- In advance, spread out 4 to 5 rows of assorted boards according to joints and colours.
- From the starting point outward, apply the adhesive with your trowel at 45°. It is important to use the manufacturer's recommended trowel to apply the correct amount of adhesive.
- Nail the guide slats inside the work area along the line. The latter will serve as point of support points for installation of the first boards.
- Install the first board along the starting line so that the groove is towards you and the tongue is faced towards the starting wall. Always keep a 1/4" (6 mm) expansion gap at the end of rows.
- Proceed in small sections so that the adhesive does not dry before the boards are installed.
- Install the other boards in the row progressing from left to right.
- The last row board will have to be cut. The remaining portion will be used to start the next row (leave at least 6" [152 mm] in length).
- For the next rows, insert the tongue into the groove and lower the boards into the adjacent board and avoid touching the adhesive. A hammer block may be required to enter the tongue into the groove.

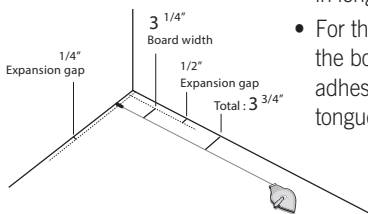
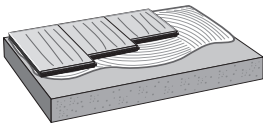

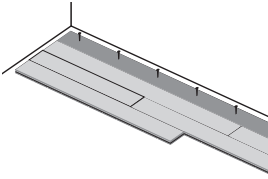

- Apply blue adhesive tape onto each 5 or 6 rows to ensure that boards remain securely in place.
- Use a 100 to 150 lb. (45 to 68 kg) roller to apply pressure on the fitted sections while the adhesive is still active (about 45 to 60 min.).
- Repeat these steps for the entire floor.
- For best results, stagger the end-joints 6" to 8" (203 mm to 152 mm) from the previous row and alternate the length of the boards.
- Once the surface is completely covered, remove the guides and place the boards within the space left free at the beginning of the installation.

Important: During installation, immediately wipe off any adhesive from the surface of the flooring using adhesive cleaner.

Herringbone Installation

For an optimal installation, Mercier recommends the installation of its Herringbone products to be carried out by a qualified professional. Herringbone Engineered floors require a glue down installation. They are designed to fit all types of subfloors; in the basement, on a floor with a radiant heating system or directly on a concrete subfloor. Herringbone floors can be installed from any point in the room but normally start in the center of the room. Use the pre-cut reversing tongues in the grooves at the ends of the boards. Those pre-cut reversing tongues should be glued with a wood covering PVA Type II glue. Depending on the site and the type of installation, the Herringbone product order should provide approximately 15% additional coverage to compensate for the loss caused by the cuts.

Nailed or stapled installation

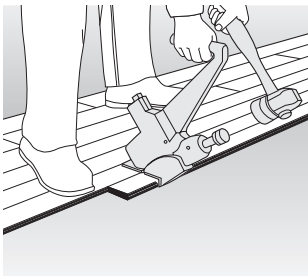

Nailed or stapled installation only applies with plywood subfloors or OSB panels.

Recommended subfloors :

- 3/4" (19 mm) plywood or OSB for joists spaced no more than 19,2" (488 mm), center to center.
- 5/8" (16 mm) plywood (minimum) for joists spaced no more than 16" (406 mm), center to center.

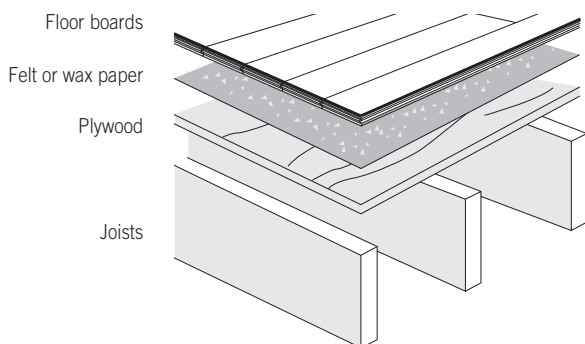

Using the nailer

- Practice handling the floor nailer on a scrap board. Follow the manufacturer's instructions and the safety instructions.
- The shoe under the nailer should be cleaned regularly to ensure that it does not damage the the finish.
- If you are using a pneumatic nailer, adjust the air pressure of the compressor and check it regularly there after.

Board installation

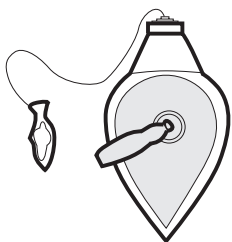

- Using chalk line, draw a line parallel to the starting wall at a distance of 1/2" (13 mm) more than the width of the boards (e.g.: 3 3/4" [95 mm] for 3 1/4" [83 mm] boards.)
- Make sure you are straight and square from the outset.
- Spread out 4 to 5 rows of boards according to joints and colour. Cut the boards with surface imperfections or place them in less visible places.
- Install the first board along the line with the tongue towards you and the groove facing the starting wall. Always keep an expansion gap of 1/4" (6 mm) at the ends of rows.
- The first row should be nailed manually. Drill holes at right angles on the top of boards as close as possible to the wall and secure with spiral finishing nails. Push in the head of nails with a nail punch. Then, drill holes at 45 ° into the tongue and insert spiral finishing nails.

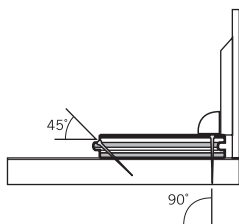

- The last board of the row will have to be cut. The remaining portion will be used to start the next row (leave at least 6" [152 mm] in length).
- In the following rows, use the manual or pneumatic nailer. The boards should be nailed at 4" to 6" (102 mm to 152 mm) and at 2" (51 mm) from the ends of the boards. See Technical bulletin #9 for more information about the nailing sequence.
- You may need a tapping block to engage the boards into each other.
- For best results, stagger the end-joints 6" (152 mm) to 8" (203 mm) joints according to the previous row and alternate the length of boards.
- The last boards should be installed in the same way as the first. It might be necessary to cut the last row length-wise to allow for the 1/2" (13 mm) expansion gap.
- It is possible - but not obligatory - to reinforce the nailing of 6 1/2" and 8 1/8" wide products with urethane-based glue, in accordance with Technical bulletin #9.

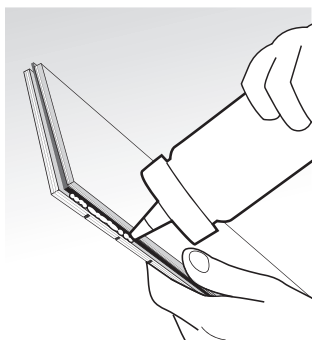

Floating installation

Engineered 1/2" (13 mm) and 3/4" (19 mm) floors can be safely installed using a floating⁵ installation method if the following instructions are observed.

Board installation

The floor must not be fixed to any surface. An expansion gap of a minimum of 1/2" (13 mm) is required for all fixed elements. See table below.

Table 1

Expansion gap	Maximum width	Maximum length
1/2" (13 mm)	26' (8 m)	52' (16 m)
3/4" (19 mm)	40' (12 m)	80' (24 m)

When the dimensions exceed the values above, use a t-molding.

- Unroll the membrane over the entire surface of the subfloor in the opposite direction to the laying of the boards (consult the documentation included with the membrane installation).

⁵ Excluding 1/2" x 6 1/2" in Hickory and 8 1/8" PLUS in Hard Maple, Red Oak and White Oak products.

- The first rows of the floor are the most important. They must be straight and all joints must fit perfectly.
- Select the longest boards so that the first row along the longest and straightest wall, is as straight as possible.
- Install the first board along the line with the tongue towards you and the groove facing the starting wall. Always keep a 1/4" (6 mm) expansion joint at the ends of rows. If the wall is not square, use wedges or shims between the hardwood boards and the wall to maintain the 1/2" (13 mm) expansion joint.
- Carefully apply a smooth, equal ribbon of glue at least 1/16" (1,6 mm) wide, but not exceeding 1/8" (3 mm) on the bottom of the groove only. Never apply glue onto the tongue and groove located at the end of the board.

NOTE: It is very important to apply the glue according to instructions. If the glue is poorly applied or of inadequate quantity, the joint could separate, while too much glue might unnecessarily complicate the task.

- Install other boards of the row from left to right.
- Immediately wipe off any excess glue with a dry cloth.
- The last board of the row will have to be cut. The remaining portion will be used to start the next row (leave at least 6" [152 mm] in length).
- Continue this way across the floor.
- It may be necessary to use a tapping block to tap the boards so they fit securely.
- For best results, stagger the end-joints 6" (152 mm) to 8" (203 mm) from the previous row and alternate the length of boards.
- It is sometimes necessary to use 3M blue tape to hold the pieces in place while the glue dries.
- Cut the boards in the last row at the correct width, considering the 1/2" (13 mm) expansion gap.

Mercier LOC installation

Mercier LOC 1/2" (13 mm) floors must not be installed using adhesive or mechanical attachments.

Board installation

- The floor must not be fixed to any surface. An expansion gap of a minimum of 1/2" (13 mm) is required for all fixed elements. See Table 1 on page 11.
- Unroll the membrane over the entire surface of the subfloor in the direction opposite to the laying of the boards (consult the documentation included with the membrane).
- The first rows of the floor are the most important. They must be straight and all joints must fit perfectly.
- If the wall is not square, use wedges or shims between the hardwood boards and the wall to maintain the 1/2" (13 mm) expansion gap.
- Proceed from left to right when facing the starting wall. Install the first board along the line with its tongue facing you.
- In the groove of the first board, insert the end of the second board, then lower it slowly. Continue installing the hardwood boards in this way for the entire length of the room making sure to leave a 1/4" (6 mm) expansion gap at each end of the row.
- The last board of the row will have to be cut. The remaining portion will be used to start the next row (leave at least 6" [152 mm] in length).
- Insert the first board of the next row by making an angle from the previous row and by pushing forward and then downwards. When properly positioned, the LOC is very easy to assemble and requires no excessive force.
- At the end of your third row, check your measurements to ensure that you are always parallel to the starting line.
- Continue installing the hardwood boards in this way across the room, making sure that the ends of the adjacent board joints are staggered at least 6" (152 mm).

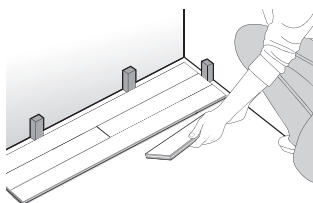

Near the door jambs at the foot of the final wall or door, it will be necessary to remove the LOC mechanism from the two pieces with scissors or a knife. Place a drop of PVA Type II glue on the groove joint, and then with a vertical motion, place the last board.

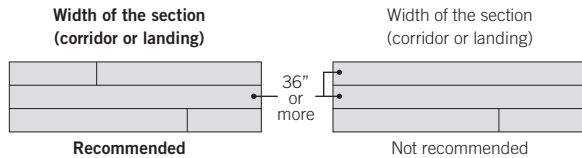

In small areas such as landings or corridors (where the boards cross any section), it is recommended to join the 36" boards or longer to reduce the risk of deflection.

Installation on radiant heating systems

Engineered 3/8" (8,5 mm), 1/2" (13 mm) and 3/4" (19 mm) floors and LOC floors, with the exception of Hickory, can be installed on a floor equipped with a radiant heating system on the ground floor, on the first floor or in the basement using the following instructions. You can access the Technical bulletin #5 regarding radiant floors at www.mercierwoodflooring.com

Precautions and recommendations:

Engineered floors must be fixed to the subfloor. For a floating installation on a radiant heating system, use LOC products.

1. The system must be tested and operational a few weeks before floor installation.
2. Close the system prior to installation.
3. The floor surface that is heated with radiant heat must never exceed 80 °F (27 °C) during use.
4. Visible or exposed pipes must be covered with 3/8" (10 mm) plywood or a layer of concrete to ensure uniform heat distribution.
5. When start-up or shutdown of the radiant heating system occurs at the beginning or at the end of seasons, gradually increase the temperature to limit the stress on the wood.

Specific circumstances

Transition moldings

As part of your installation, you may have to install stair nosing, T-moldings, quarter-rounds and level reducers. These moldings are available in the same colours and species as your Mercier floor, and are available at your authorized Mercier retailer. These moldings should be ordered at the same time as your hardwood floor.

Prior to installation of the flooring, it is recommended to select boards which combine well with moldings to not cause “breaks” in the appearance of the floor.

WARNING!

It is suggested to pre-drill moldings to avoid cracking them when they are nailed.

If you install moldings, such as baseboards or quarter rounds, these should be affixed to the wall and not to the wood floor to allow for the movement of the floor.

Always respect the recommended space for the expansion gap.

Inspection, finishing and maintenance

Once installation is complete, vacuum the floor and clean the surface using Mercier Maintenance kit according to instructions. NEVER wash a hardwood floor with water.

You can hide small holes and marks left by the surface nails by using a Mercier Touch-up kit. For more information, see Technical bulletin #7.



MERCIER

wood flooring

mercierwoodflooring.com 1.866.448.1785